

# MJ11021 (PNP) MJ11022 (NPN)

## Complementary Darlington Silicon Power Transistors

Complementary Darlington Silicon Power Transistors are designed for use as general purpose amplifiers, low frequency switching and motor control applications.

### Features

- High dc Current Gain @ 10 Adc –  $h_{FE} = 400$  Min (All Types)
- Collector–Emitter Sustaining Voltage  
 $V_{CEO(sus)} = 250$  Vdc (Min) – MJ11022, 21
- Low Collector–Emitter Saturation  
 $V_{CE(sat)} = 1.0$  V (Typ) @  $I_C = 5.0$  A  
 $= 1.8$  V (Typ) @  $I_C = 10$  A
- 100% SOA Tested @  $V_{CE} = 44$  V  
 $I_C = 4.0$  A  
 $t = 250$  ms
- Pb–Free Packages are Available\*

### MAXIMUM RATINGS ( $T_J = 25^\circ\text{C}$ unless otherwise noted)

Rating	Symbol	Value	Unit
Collector–Emitter Voltage	$V_{CEO}$	250	Vdc
Collector–Base Voltage	$V_{CBO}$	250	Vdc
Emitter–Base Voltage	$V_{EBO}$	50	Vdc
Collector Current – Continuous – Peak (Note 1)	$I_C$	15 30	Adc
Base Current	$I_B$	0.5	Adc
Total Power Dissipation @ $T_C = 25^\circ\text{C}$ Derate Above $25^\circ\text{C}$	$P_D$	175 1.16	W W/ $^\circ\text{C}$
Operating and Storage Junction Temperature Range	$T_J, T_{stg}$	$-65$ to $+175$ $-65$ to $+200$	$^\circ\text{C}$

### THERMAL CHARACTERISTICS

Characteristic	Symbol	Max	Unit
Thermal Resistance, Junction–to–Case	$R_{\theta JC}$	0.86	$^\circ\text{C}/\text{W}$

Maximum ratings are those values beyond which device damage can occur. Maximum ratings applied to the device are individual stress limit values (not normal operating conditions) and are not valid simultaneously. If these limits are exceeded, device functional operation is not implied, damage may occur and reliability may be affected.

1. Pulse Test: Pulse Width = 5 ms, Duty Cycle  $\leq 10\%$ .

\*For additional information on our Pb–Free strategy and soldering details, please download the ON Semiconductor Soldering and Mounting Techniques Reference Manual, SOLDERRM/D.



**ON Semiconductor®**

<http://onsemi.com>

## 15 AMPERE COMPLEMENTARY DARLINGTON POWER TRANSISTORS 250 VOLTS, 175 WATTS

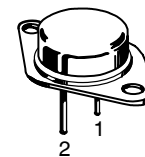
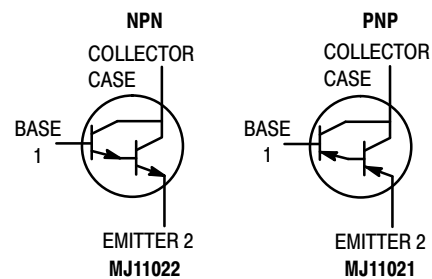

TO–204 (TO–3)  
CASE 1–07  
STYLE 1

### MARKING DIAGRAM

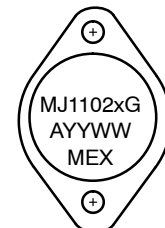

MJ1102x = Device Code  
x = 1 or 2  
G = Pb–Free Package  
A = Location Code  
YY = Year  
WW = Work Week  
MEX = Country of Origin

### ORDERING INFORMATION

Device	Package	Shipping
MJ11021	TO–3	100 Units/Tray
MJ11021G	TO–3 (Pb–Free)	100 Units/Tray
MJ11022	TO–3	100 Units/Tray
MJ11022G	TO–3 (Pb–Free)	100 Units/Tray

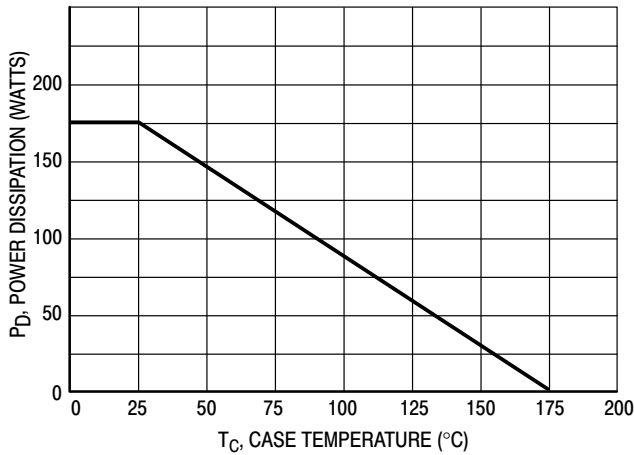
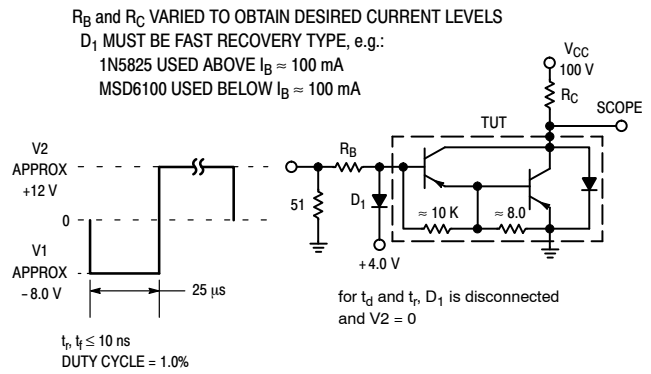

Figure 1. Power Derating



For NPN test circuit reverse diode and voltage polarities.

Figure 2. Switching Times Test Circuit

**ELECTRICAL CHARACTERISTICS** ( $T_C = 25^\circ\text{C}$  unless otherwise noted)

Characteristic	Symbol	Min	Max	Unit	
<b>OFF CHARACTERISTICS</b>					
Collector-Emitter Sustaining Voltage (Note 1) ( $I_C = 0.1 \text{ Adc}$ , $I_B = 0$ )	MJ11021, MJ11022	$V_{CEO(sus)}$	250	-	Vdc
Collector Cutoff Current ( $V_{CE} = 125$ , $I_B = 0$ )	MJ11021, MJ11022	$I_{CEO}$	-	1.0	mAdc
Collector Cutoff Current ( $V_{CE} = \text{Rated } V_{CB}$ , $V_{BE(off)} = 1.5 \text{ Vdc}$ ) ( $V_{CE} = \text{Rated } V_{CB}$ , $V_{BE(off)} = 1.5 \text{ Vdc}$ , $T_J = 150^\circ\text{C}$ )		$I_{CEV}$	-	0.5 5.0	mAdc
Emitter Cutoff Current ( $V_{BE} = 5.0 \text{ Vdc}$ , $I_C = 0$ )		$I_{EBO}$	-	2.0	mAdc
<b>ON CHARACTERISTICS</b> (Note 1)					
DC Current Gain ( $I_C = 10 \text{ Adc}$ , $V_{CE} = 5.0 \text{ Vdc}$ ) ( $I_C = 15 \text{ Adc}$ , $V_{CE} = 5.0 \text{ Vdc}$ )		$h_{FE}$	400 100	15,000 -	-
Collector-Emitter Saturation Voltage ( $I_C = 10 \text{ Adc}$ , $I_B = 100 \text{ mA}$ ) ( $I_C = 15 \text{ Adc}$ , $I_B = 150 \text{ mA}$ )		$V_{CE(sat)}$	-	2.0 3.4	Vdc
Base-Emitter On Voltage $I_C = 10 \text{ A}$ , $V_{CE} = 5.0 \text{ Vdc}$		$V_{BE(on)}$	-	2.8	Vdc
Base-Emitter Saturation Voltage ( $I_C = 15 \text{ Adc}$ , $I_B = 150 \text{ mA}$ )		$V_{BE(sat)}$	-	3.8	Vdc
<b>DYNAMIC CHARACTERISTICS</b>					
Current-Gain Bandwidth Product ( $I_C = 10 \text{ Adc}$ , $V_{CE} = 3.0 \text{ Vdc}$ , $f = 1.0 \text{ MHz}$ )		$[h_{fe}]$	3.0	-	Mhz
Output Capacitance ( $V_{CB} = 10 \text{ Vdc}$ , $I_E = 0$ , $f = 0.1 \text{ MHz}$ )	MJ11022 MJ11021	$C_{ob}$	-	400 600	pF
Small-Signal Current Gain ( $I_C = 10 \text{ Adc}$ , $V_{CE} = 3.0 \text{ Vdc}$ , $f = 1.0 \text{ kHz}$ )		$h_{fe}$	75	-	-

**SWITCHING CHARACTERISTICS**

Characteristic	Symbol	Typical		Unit
		NPN	PNP	
Delay Time	$t_d$	150	75	ns
Rise Time	$t_r$	1.2	0.5	$\mu\text{s}$
Storage Time	$t_s$	4.4	2.7	$\mu\text{s}$
Fall Time	$t_f$	10.0	2.5	$\mu\text{s}$

$(V_{CC} = 100 \text{ V}$ ,  $I_C = 10 \text{ A}$ ,  $I_B = 100 \text{ mA}$   
 $V_{BE(off)} = 50 \text{ V}$ ) (See Figure 2)

1. Pulsed Test: Pulse Width = 300  $\mu\text{s}$ , Duty Cycle  $\leq 2\%$ .

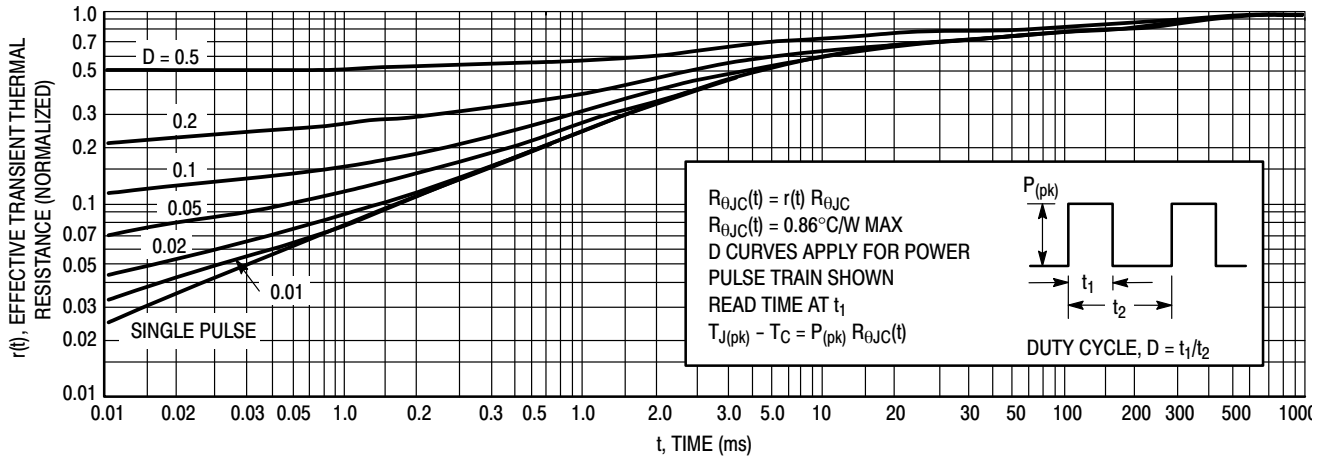

Figure 3. Thermal Response

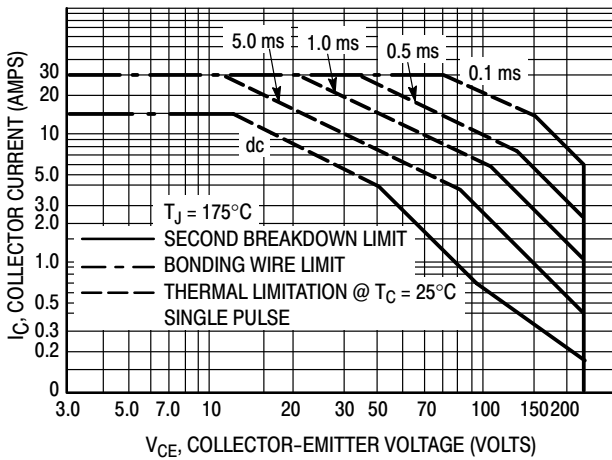

Figure 4. Maximum Rated Forward Bias Safe Operating Area (FBSOA)

**FORWARD BIAS**

There are two limitations on the power handling ability of a transistor average junction temperature and second breakdown. Safe operating area curves indicate  $I_C - V_{CE}$  limits of the transistor that must be observed for reliable operation, i.e., the transistor must not be subjected to greater dissipation than the curves indicate.

The data of Figure 4 is based on  $T_{J(pk)} = 175^\circ\text{C}$ ,  $T_C$  is variable depending on conditions. Second breakdown pulse limits are valid for duty cycles to 10% provided  $T_{J(pk)} \leq 175^\circ\text{C}$ .  $T_{J(pk)}$  may be calculated from the data in Figure 3. At high case temperatures thermal limitations will reduce the power that can be handled to values less than the limitations imposed by second breakdown.

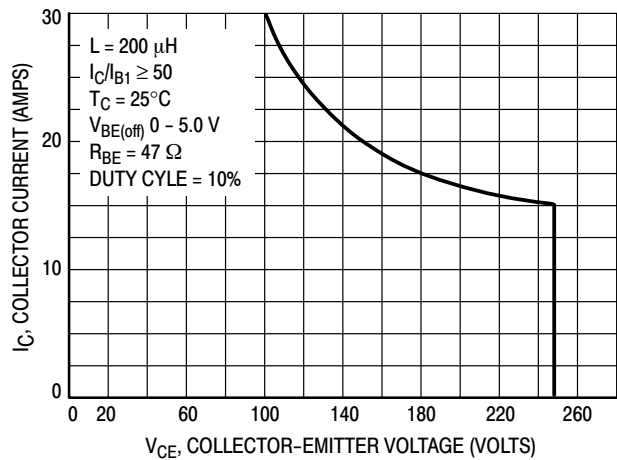

Figure 5. Maximum RBSOA, Reverse Bias Safe Operating Area

**REVERSE BIAS**

For inductive loads, high voltage and high current must be sustained simultaneously during turn-off, in most cases, with the base to emitter junction reverse biased. Under these conditions the collector voltage must be held to a safe level at or below a specific value of collector current. This can be accomplished by several means such as active clamping, RC snubbing, load line shaping, etc. The safe level for these devices is specified as Reverse Bias Safe Operating Area and represents the voltage-current conditions during reverse biased turn-off. This rating is verified under clamped conditions so that the device is never subjected to an avalanche mode. Figure 5 gives ROSOA characteristics.

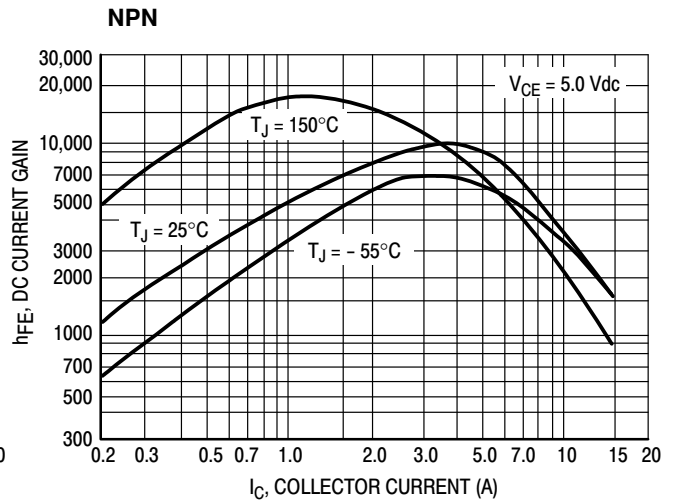
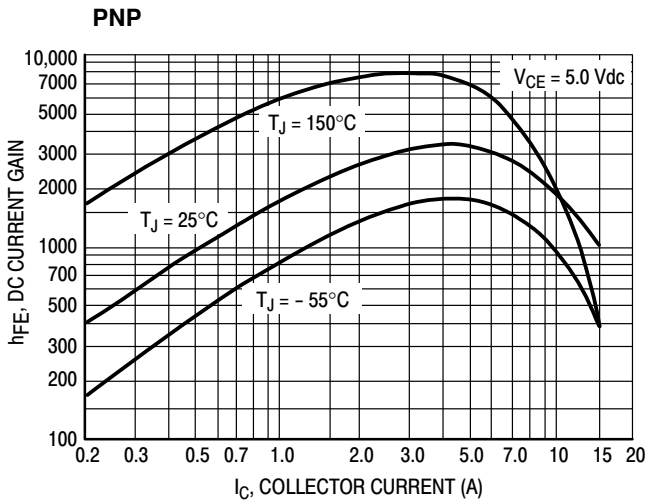

Figure 6. DC Current Gain

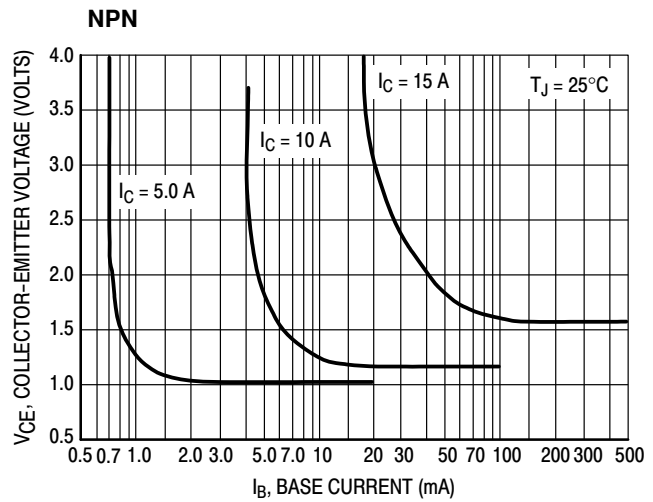
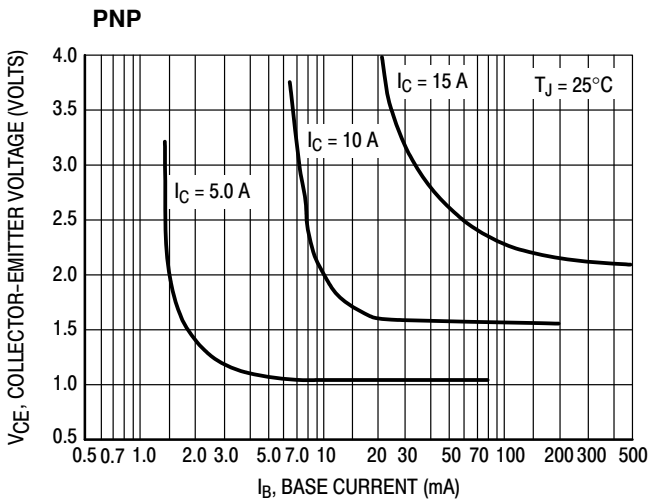

Figure 7. Collector Saturation Region

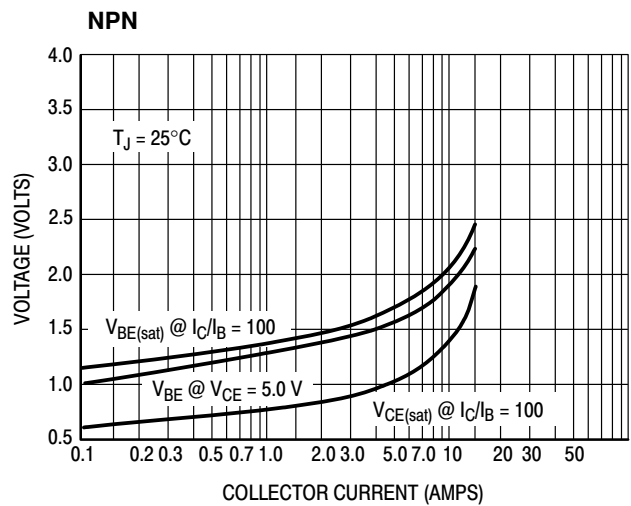
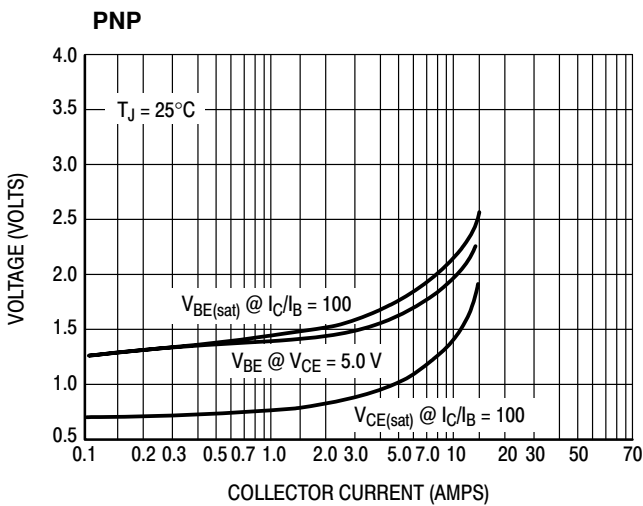
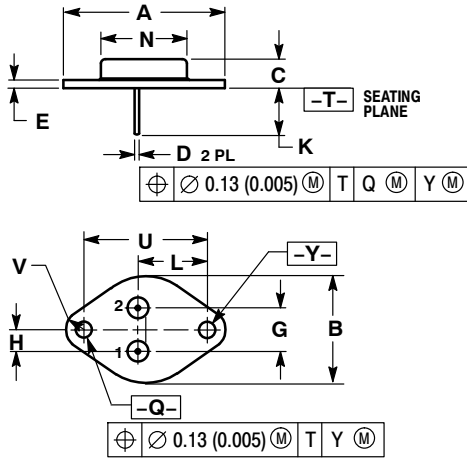

Figure 8. "On" Voltages

# MJ11021(PNP) MJ11022 (NPN)

## PACKAGE DIMENSIONS

TO-204 (TO-3)  
CASE 1-07  
ISSUE Z



- NOTES:
1. DIMENSIONING AND TOLERANCING PER ANSI Y14.5M, 1982.
  2. CONTROLLING DIMENSION: INCH.
  3. ALL RULES AND NOTES ASSOCIATED WITH REFERENCED TO-204AA OUTLINE SHALL APPLY.

DIM	INCHES		MILLIMETERS	
	MIN	MAX	MIN	MAX
A	1.550 REF		39.37 REF	
B	---	1.050	---	26.67
C	0.250	0.335	6.35	8.51
D	0.038	0.043	0.97	1.09
E	0.055	0.070	1.40	1.77
G	0.430 BSC		10.92 BSC	
H	0.215 BSC		5.46 BSC	
K	0.440	0.480	11.18	12.19
L	0.665 BSC		16.89 BSC	
N	---	0.830	---	21.08
Q	0.151	0.165	3.84	4.19
U	1.187 BSC		30.15 BSC	
V	0.131	0.188	3.33	4.77

- STYLE 1:  
PIN 1. BASE  
2. EMITTER  
CASE: COLLECTOR

ON Semiconductor and are registered trademarks of Semiconductor Components Industries, LLC (SCILLC). SCILLC reserves the right to make changes without further notice to any products herein. SCILLC makes no warranty, representation or guarantee regarding the suitability of its products for any particular purpose, nor does SCILLC assume any liability arising out of the application or use of any product or circuit, and specifically disclaims any and all liability, including without limitation special, consequential or incidental damages. "Typical" parameters which may be provided in SCILLC data sheets and/or specifications can and do vary in different applications and actual performance may vary over time. All operating parameters, including "Typicals" must be validated for each customer application by customer's technical experts. SCILLC does not convey any license under its patent rights nor the rights of others. SCILLC products are not designed, intended, or authorized for use as components in systems intended for surgical implant into the body, or other applications intended to support or sustain life, or for any other application in which the failure of the SCILLC product could create a situation where personal injury or death may occur. Should Buyer purchase or use SCILLC products for any such unintended or unauthorized application, Buyer shall indemnify and hold SCILLC and its officers, employees, subsidiaries, affiliates, and distributors harmless against all claims, costs, damages, and expenses, and reasonable attorney fees arising out of, directly or indirectly, any claim of personal injury or death associated with such unintended or unauthorized use, even if such claim alleges that SCILLC was negligent regarding the design or manufacture of the part. SCILLC is an Equal Opportunity/Affirmative Action Employer. This literature is subject to all applicable copyright laws and is not for resale in any manner.

### PUBLICATION ORDERING INFORMATION

**LITERATURE FULFILLMENT:**  
Literature Distribution Center for ON Semiconductor  
P.O. Box 5163, Denver, Colorado 80217 USA  
**Phone:** 303-675-2175 or 800-344-3860 Toll Free USA/Canada  
**Fax:** 303-675-2176 or 800-344-3867 Toll Free USA/Canada  
**Email:** orderlit@onsemi.com

**N. American Technical Support:** 800-282-9855 Toll Free  
USA/Canada  
**Europe, Middle East and Africa Technical Support:**  
Phone: 421 33 790 2910  
**Japan Customer Focus Center**  
Phone: 81-3-5773-3850

**ON Semiconductor Website:** [www.onsemi.com](http://www.onsemi.com)  
**Order Literature:** <http://www.onsemi.com/orderlit>  
For additional information, please contact your local Sales Representative